



Co-funded by the
Erasmus+ Programme
of the European Union



Digital Factory Simulation of a production line

Module II: Digital Factory Modeling: How to formulate a virtual world

Professor Dr. Athakorn Kengpol, KMUTNB

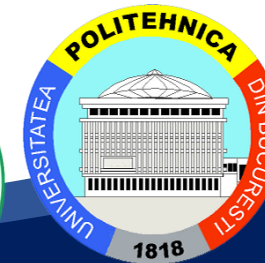

Curriculum Development
of Master's Degree Program in
Industrial Engineering for Thailand Sustainable Smart Industry



Contents Production line simulation

- The vision of the Digital Factory
- Simulation in Digital Manufacturing
- Product and production lifecycle simulation
- Digitalization in simulation towards the 4th industrial revolution
- Production Engineering in Digital Factory
- Factory design and Optimization in Digital Factory
- Simulation of Robotic Workcells
- Human Resource Simulation
- Siemens Tecnomatix Digital Industries Software
- Benefits, limitations and future challenges
- Activity (Lab Sheet)





Learning Outcomes

- Simulate the dynamic behavior of a production line and identify locations which must be closely monitored to keep productivity in control, as well as to prevent work defects and machine breakdowns (Analysis, Module II)



The vision of the Digital Factory

The digital factory concept is an integrated approach to enhance the product and production engineering processes and simulation is a key technology in digital factory concepts.

- Product development, test and optimization
- Production process development and optimization
- Plant design and improvement
- Operative production planning and control

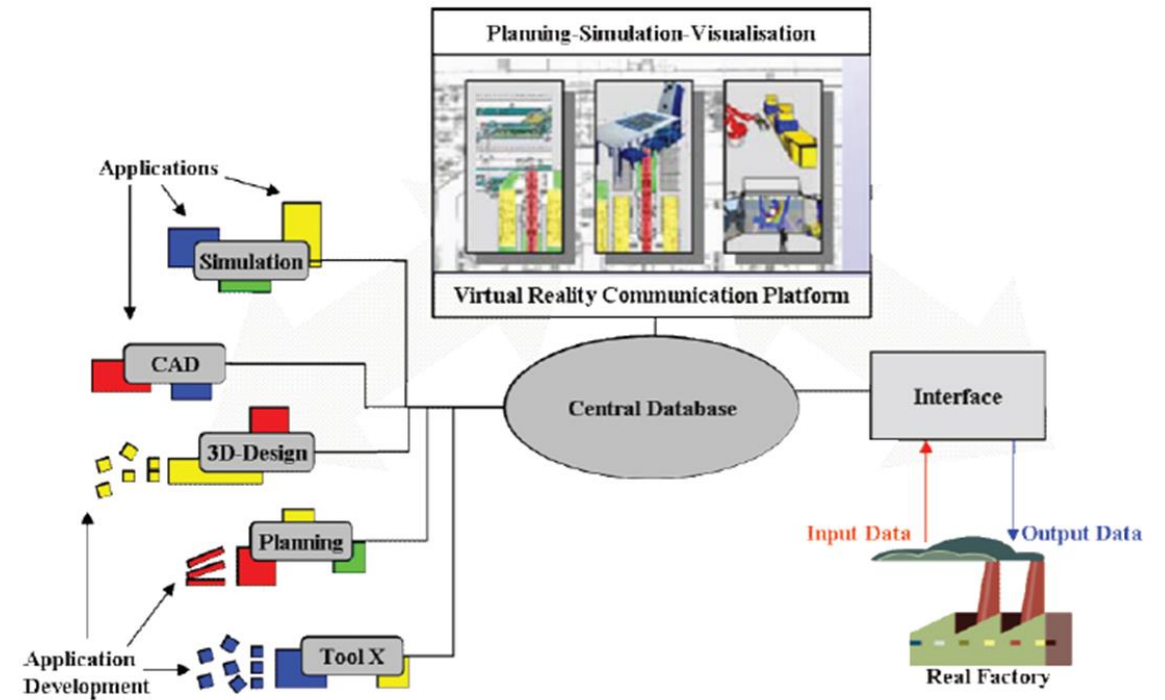

The vision of the digital factory (Bracht U., 2005)

The vision of the Digital Factory

Utilization of digital technology for modeling, and communications to

- Configure: to set up for operation especially in a particular way
- Model: the process of creating and analyzing a digital prototype to predict its performance in the real world.
- Simulate: Approximate imitation of the operation of a process or system
- Assess: Evaluate or Analyze result
- operate a manufacturing process

Factory of the Future

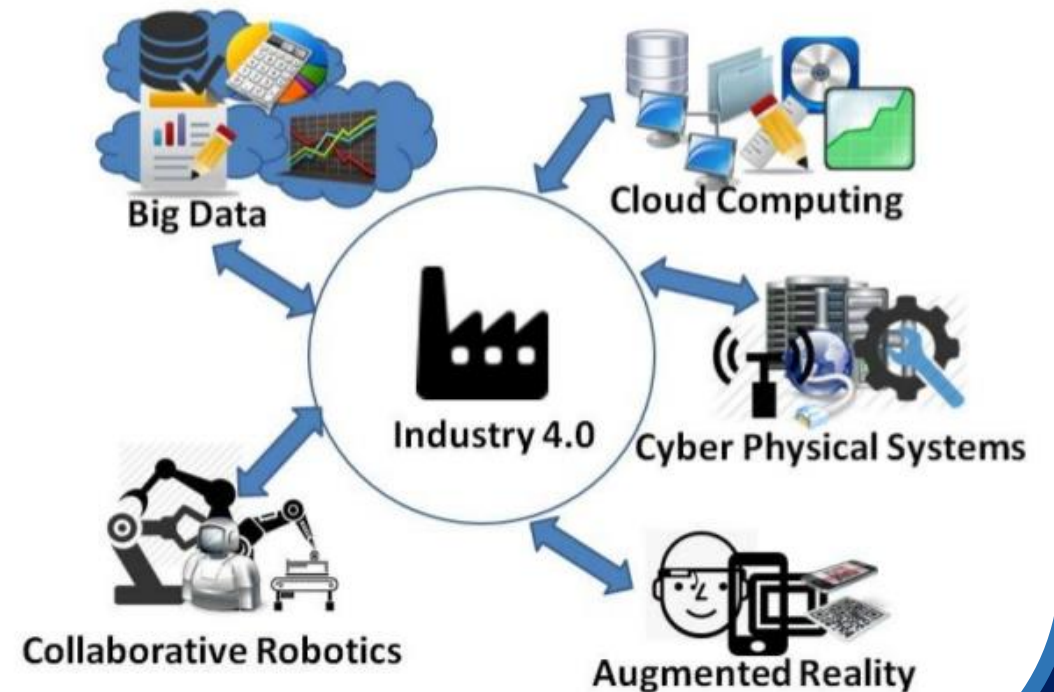

□ Why Digital Factory Simulation?

- Manufacturing Innovation & Efficiency
- Improve Visibility & Control
- Optimize Complex Processes
- Factory simulation is an inexpensive
- Risk-free way to put your facility to the test
- Help to get the information to make better, safer decisions



Source: <https://www.haptic.ro/digital-plug-produce-online-equipment-platform-manufacturing/>

Simulation in Digital Manufacturing

“Simulation modelling and analysis is the process of creating and experimenting with a computerized mathematical model of a physical system that the imitation of the operation of a real-world process or system over time.” (Chung C., 2004)

Simulation is a key technology (Finite Element Method; FEM) for enhancing the product and production engineering processes in digital factory environments.

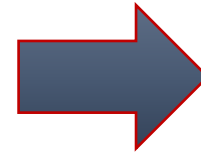

- FEM-Simulation
- Motion simulation
- Discrete-event simulation

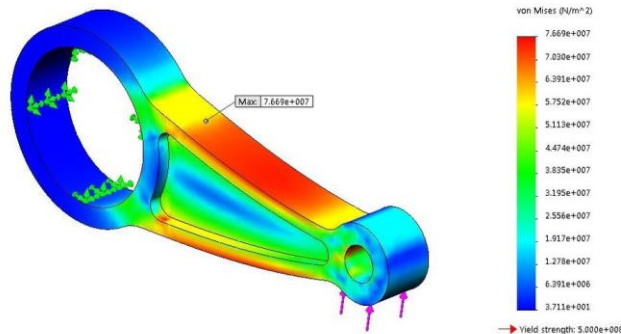

Source: <https://www.thirteendesignconsultancy.com/finite-element-analysis-fea>

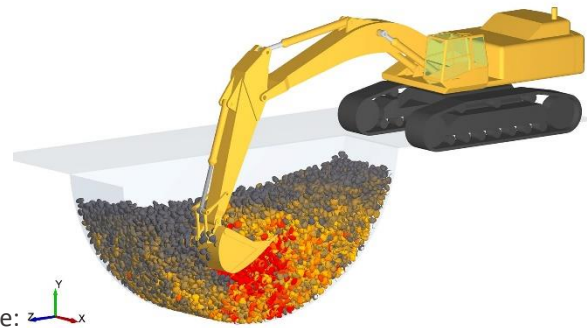

Source: <https://www.plm.automation.siemens.com/global/en/product/s/simulation-test/motion-simulation.html>

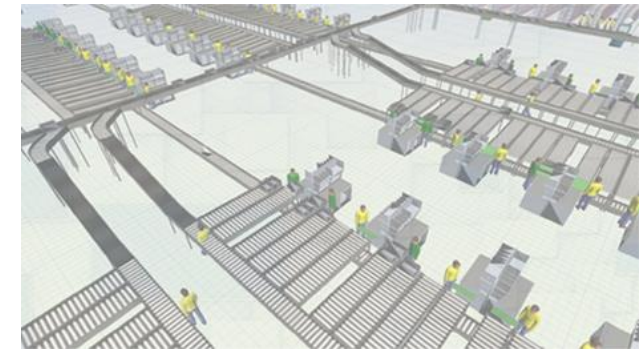

Source: <http://bestirtech.com/blog/2019/07/what-is-discrete-event-simulation/>

Simulation in Digital Manufacturing

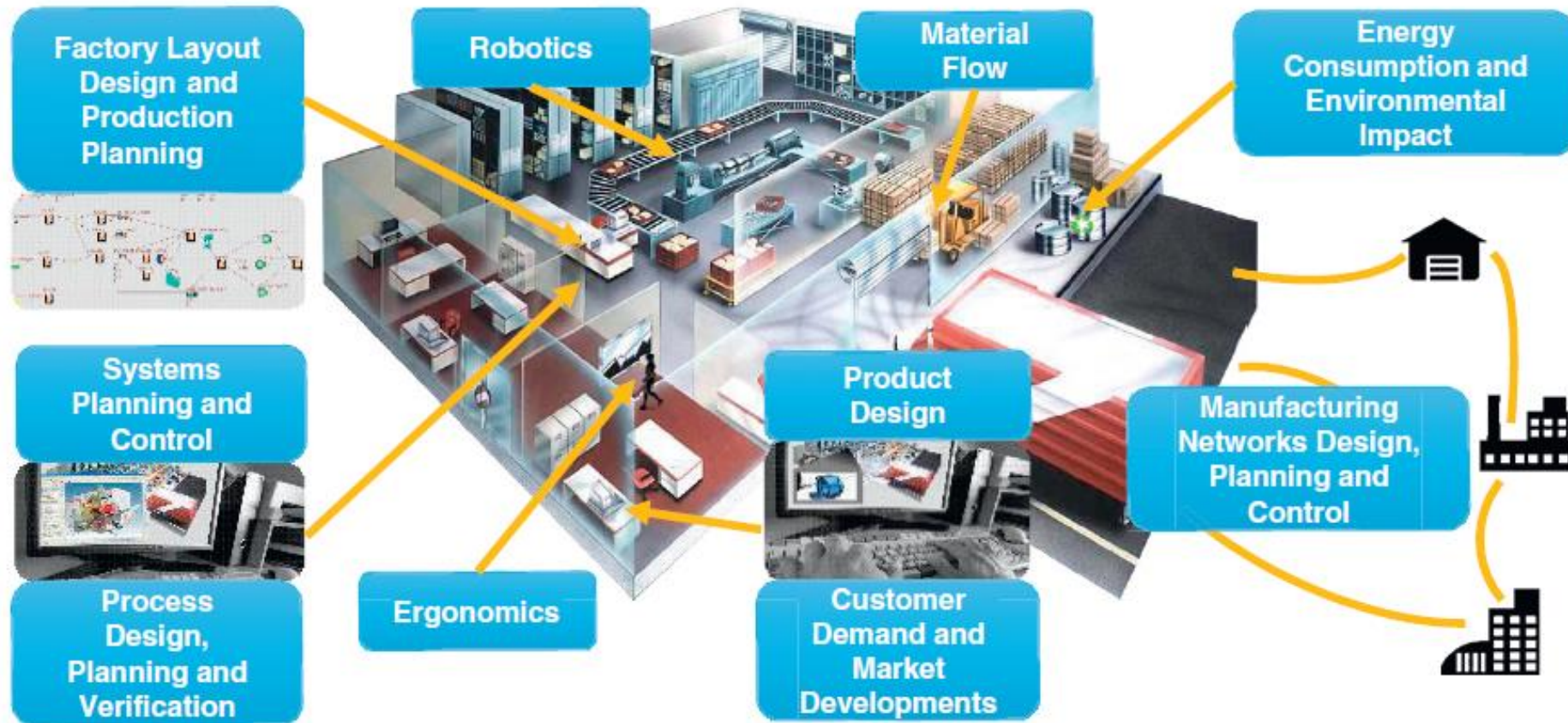

The investigated domains of contemporary manufacturing (Mourtzis,2014)

Simulation in Digital Manufacturing

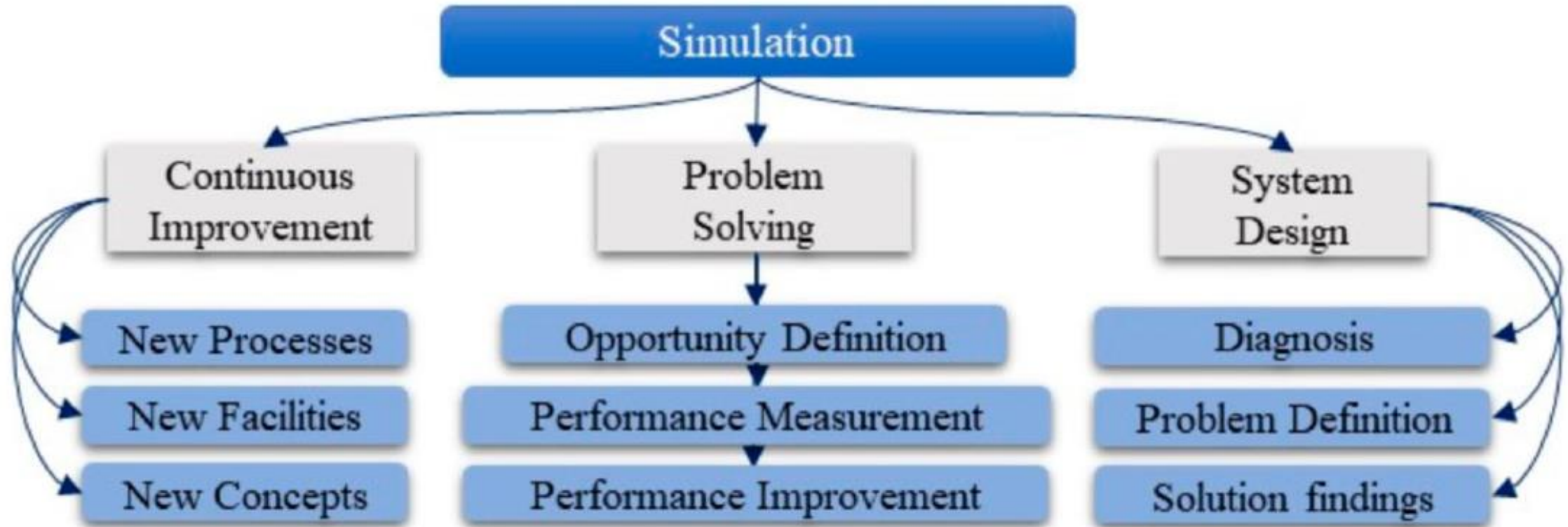

Simulation for design and operation of manufacturing systems (Mourtzis,2019)



Simulation in Digital Manufacturing

Historical evolution of simulation methods

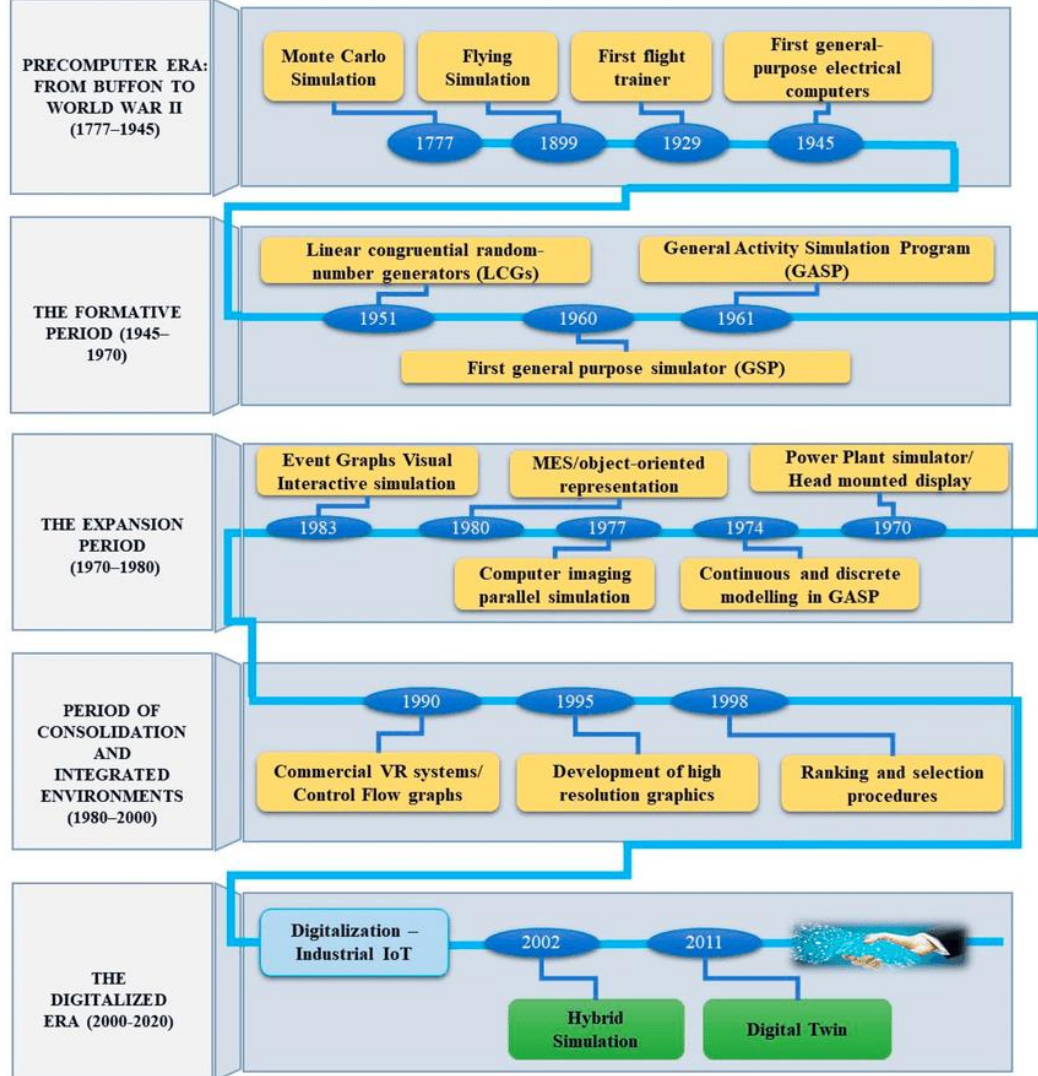

Product and Production Lifecycle Simulation Tools – State of the Art

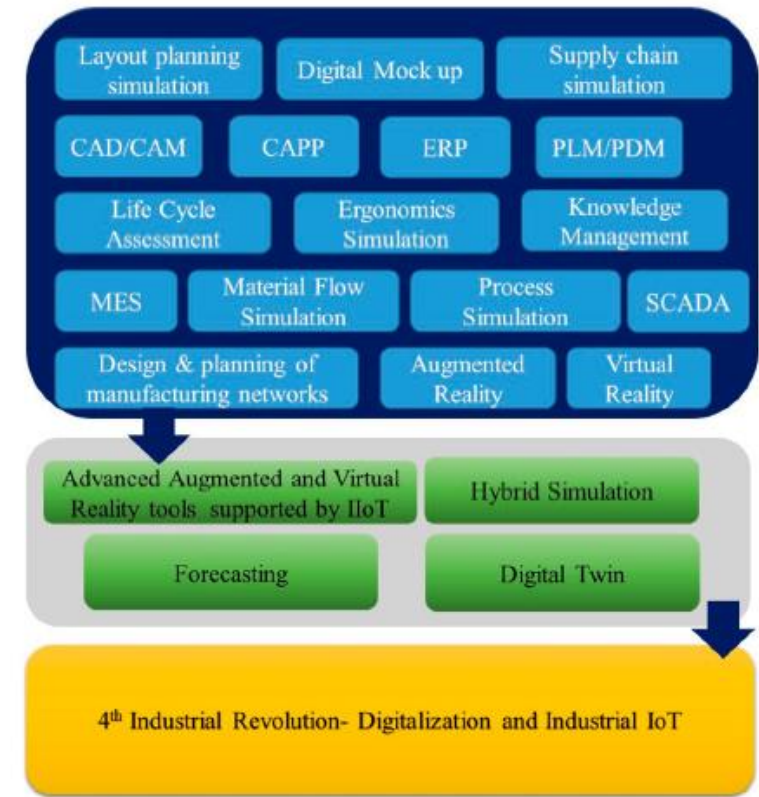

From Past
↓
To Today

Evolution of simulation (Mourtzis,2019)

co-funded by the Erasmus+ Programme of the European Union





Simulation in Digital Manufacturing

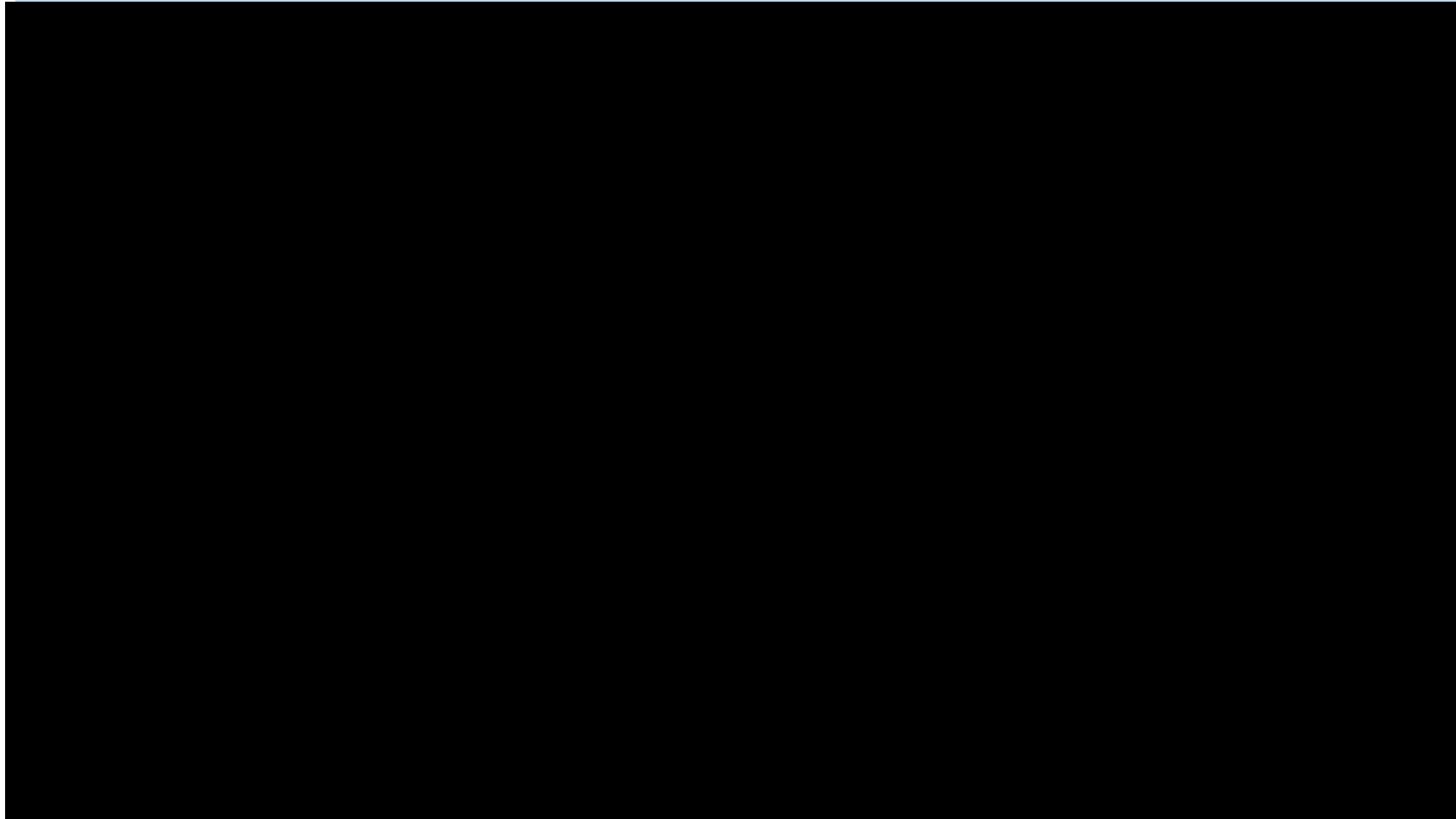

Product and production lifecycle simulation

The digital factory concept enables the integration of CAD designs and CAE information and the synchronization of the engineering processes that require the participation of the entire value chain accessing all product information needed.



Source: <https://getfreepoint.com/digital-manufacturing-future-factory-now/>

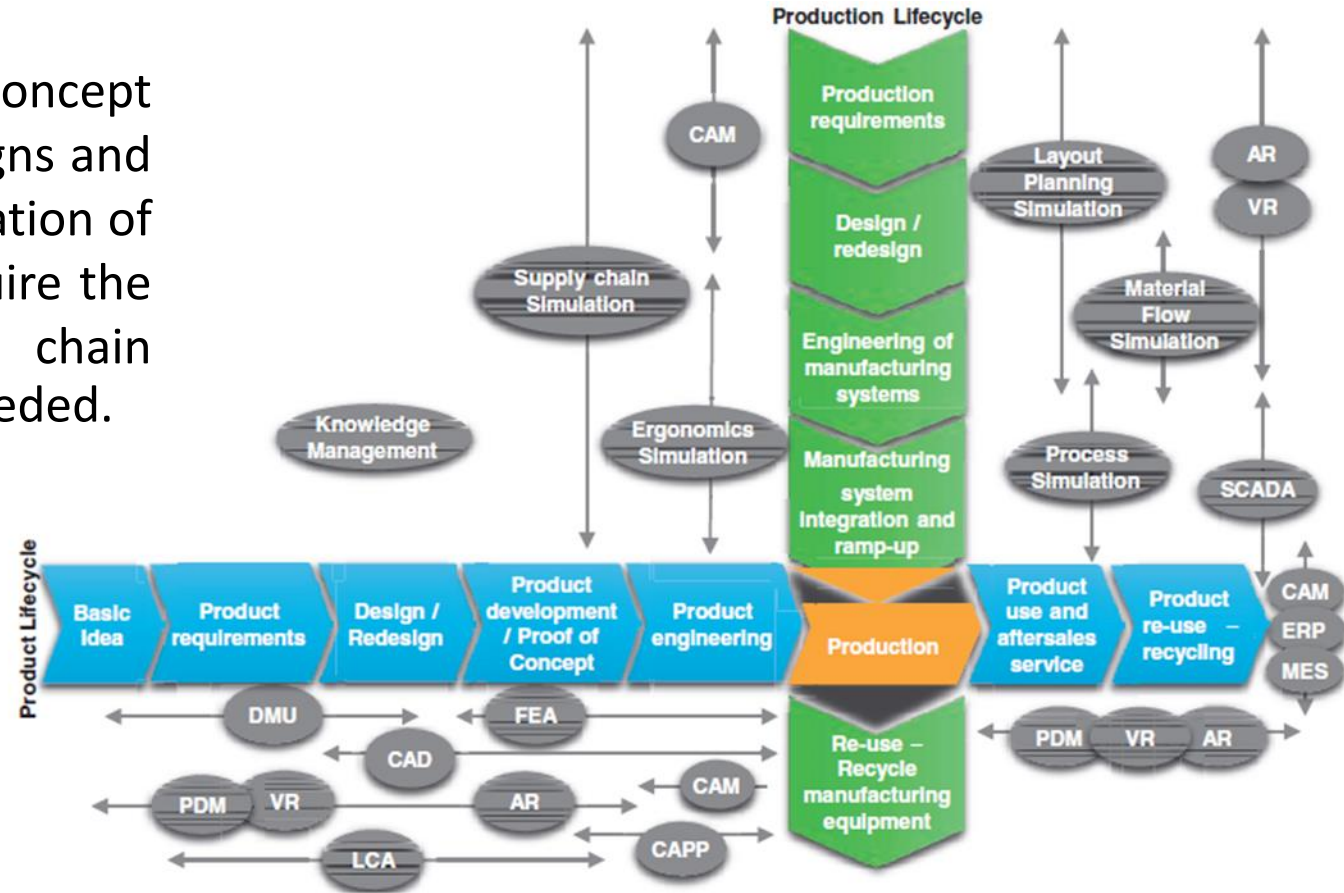

Mapping of Key-Enabling Technologies on Product and Production lifecycle [lifecycle phases adapted from EFFRA FoF 2020 Consultation Document]



Computer-aided design

Computer-Aided Design (CAD) is the technology related to the use of computer systems to assist in the creation, modification, analysis, and optimization of a design.

Computer aided process planning

Process planning deals with the selection of necessary manufacturing processes and the determination of their sequences to 'transform' the ideas of designers into a physical component.

Computer aided manufacturing

Computer Aided Manufacturing (CAM) can be perceived as the use of computer systems to plan, manage, and control the operations of a manufacturing plant

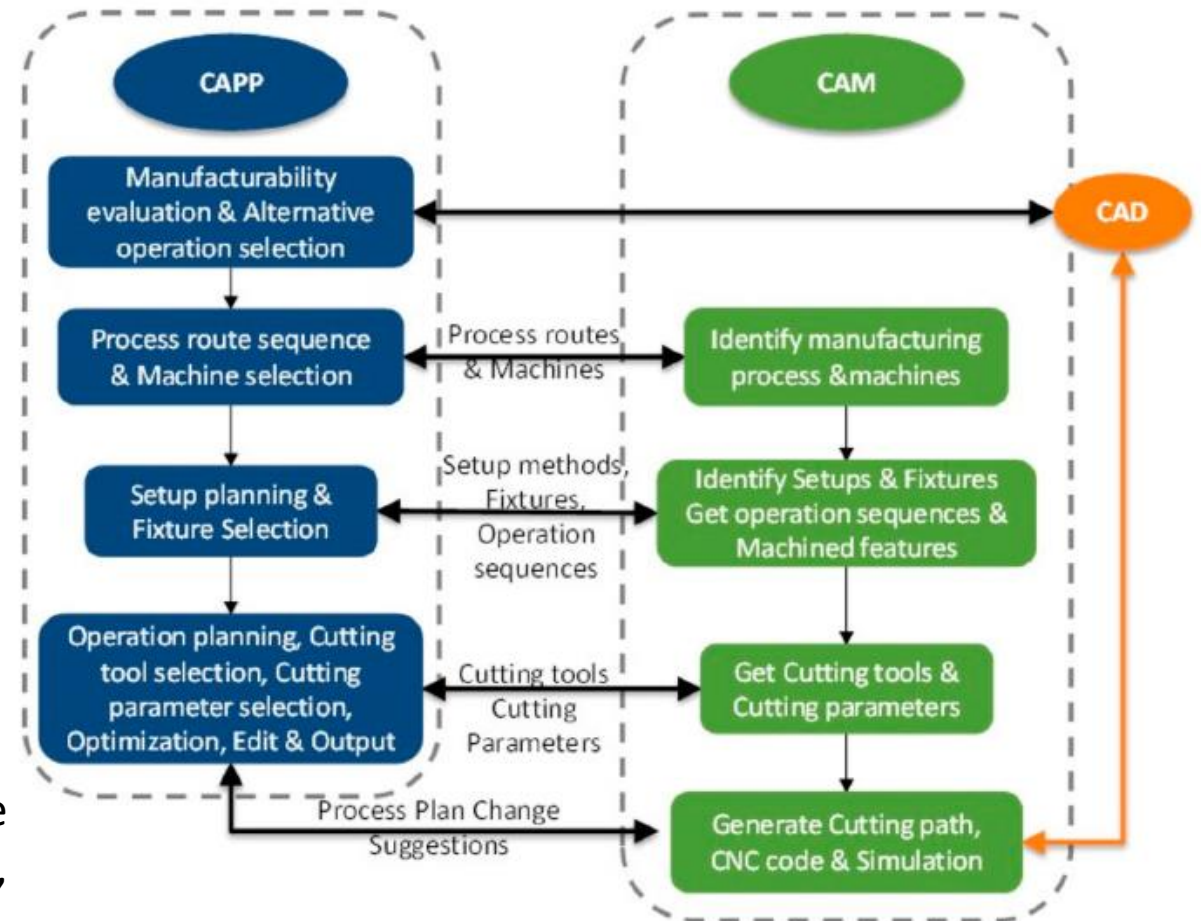

Source: Relations between CAM, CAPP, and CAD systems (Ming et al. 2008).

❑ Digital mock up; DMU

A digital mock-up (DMU) consists of 3D models in an engineering environment and spans the whole product lifecycle : design, test, manufacturing, inspection and QA, installation, maintenance, disposal, etc.

- Significantly shorten the time to market.
- Design optimization and product quality improvement.
- Cost reduction in all processes along the product lifecycle.



Source: SIEMENS



Co-funded by the
Erasmus+ Programme
of the European Union



Source: <https://fliphtml5.com/lcuh/xbfj/basic>



Product and production lifecycle simulation

❑ Product Design Suite Test Drive -- Large Scale Digital Mockup





Product and production lifecycle simulation

Life Cycle Assessment (LCA)

- Integrated in a simulation tool for discrete event modelling of manufacturing processes
- Enables the characterization of single machine behavior
- The evaluation of environmental implications of industrial
- Operation management before the real configuration of the manufacturing line



Source: <http://www.danbach.net/robot/factory/8.html>

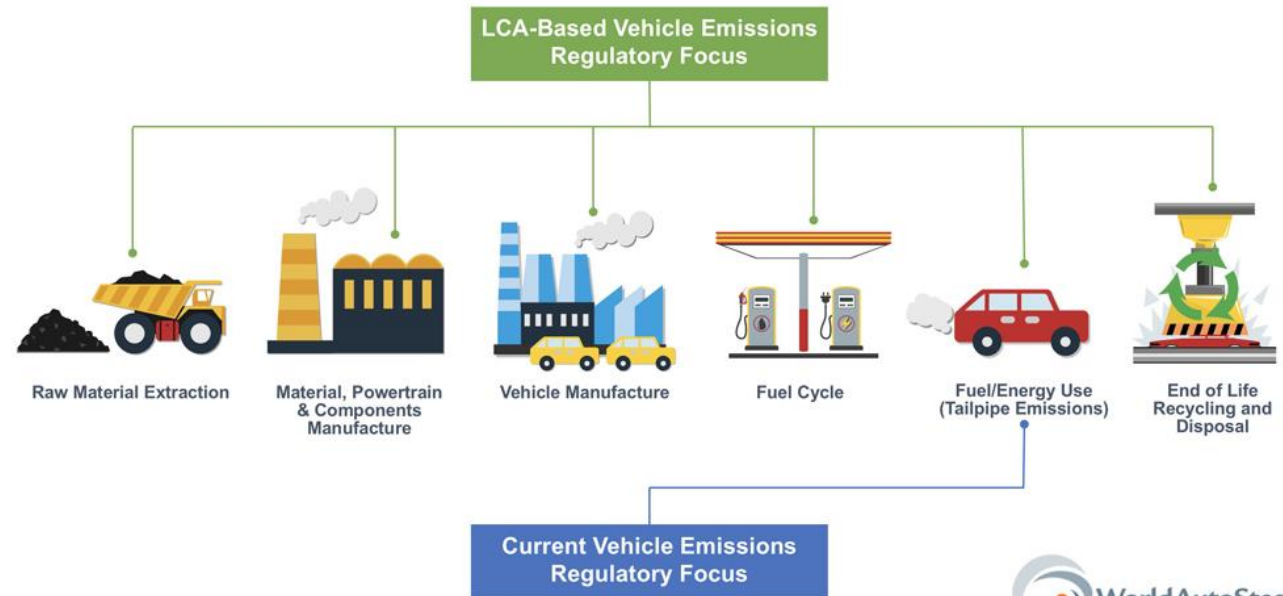

Product and production lifecycle simulation

Product Data Management (PDM)

Product data management integrates and manages all the information that defines a product, from design to manufacture and to end-user support.



Source: <http://blog.mygetit.com/2017/12/07/digital-twins-feedback-loops-and-plm-challenge/>

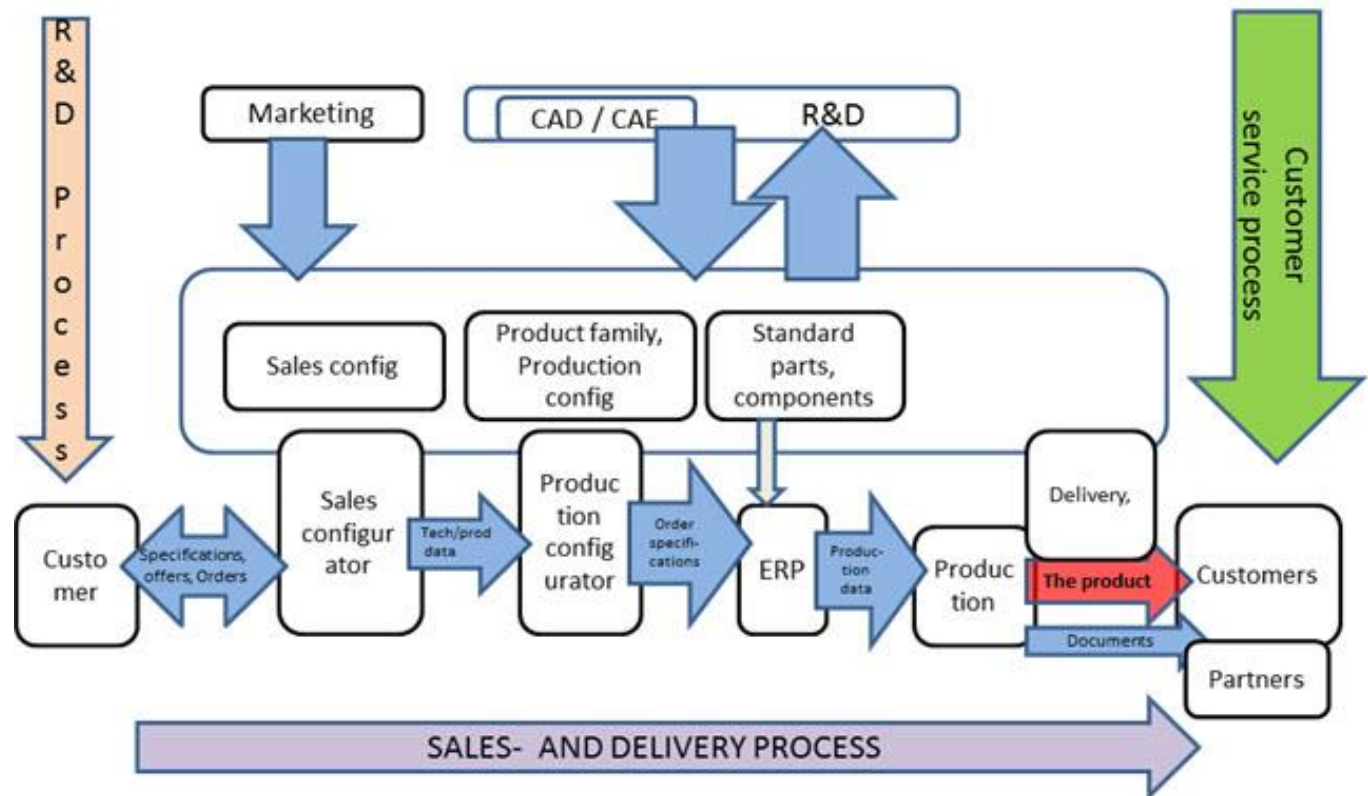

❑ Virtual Reality (VR) and Augmented Reality (AR)

Virtual Reality (VR) is defined as the use of real-time digital computers and other special hardware and software to generate the simulation of an alternate world or environment, believable as real or true by the users.

Augmented Reality (AR) is defined as a real-time direct or indirect view of a physical real-world environment that has been enhanced/augmented by adding virtual computer generated information to it.



Source: <https://realworld-one.com/virtual-and-augmented-reality-set-for-success-in-the-manufacturing-industry-of-the-future/>



Product and production lifecycle simulation

- ❑ The Merging of Augmented Reality AR, Virtual Reality VR and Mixed Reality in 2020





Product and production lifecycle simulation

□ Material flow simulation

Material flow within a manufacturing environment is the movement of materials through a defined process or a value stream within a factory or an industrial unit for the purpose of producing a finished product.

- Support from the assessment of requirements to the final result
- Visualization of complex process sequences and effects
- Selection of new systems to extend an existing facility or plan a new one
- Dimensioning of buffer capacities

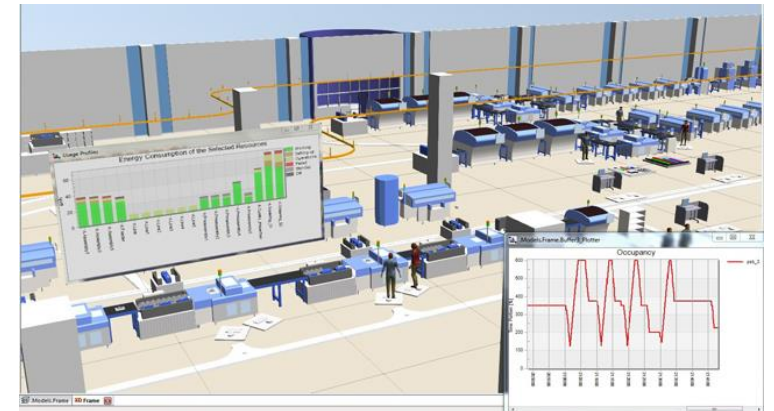
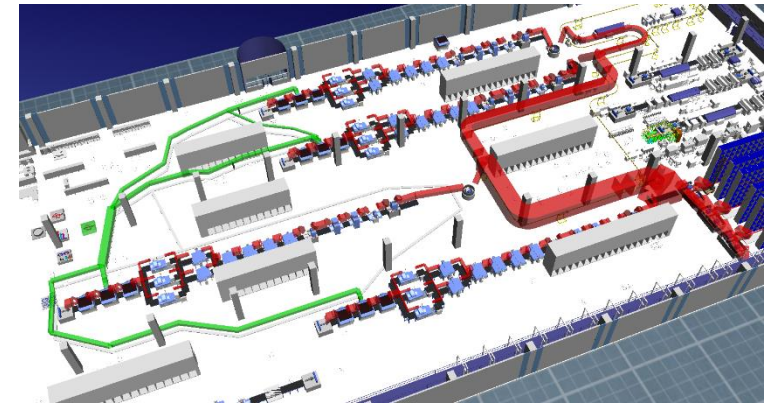

Source: SIEMENS_Tecnomatix





Product and production lifecycle simulation

□ Process simulation

A manufacturing process is defined as the use of one or more physical mechanisms to transform the shape of a material's shape or form and properties.

- Reduction of capital cost by better design
- Reduction of time for design, commissioning, and start-up
- Reduction of pilot plant cost, size, and complexity
- Improved productivity and efficiency by material and energy optimization
- Increased process knowledge and confidence in big decisions
- Training aid for new personnel
- Extension of equipment life
- Improved safety and environmental management



Source:
<https://www.youtube.com/watch?v=CN6Ztllujj4>





Product and production lifecycle simulation

□ Layout Planning Simulation

Facility layout planning refers to the redesign of the allocation plans of the resources/ equipment in a manufacturing shop floor that largely affects its performance.

- Using predefined objects, a layout model can be implemented in 3D
- Providing the user with the ability to move through factory mock-ups
- Walkthrough, inspect, and animate motion in a rendered 3D-factory model



Source: <https://www.youtube.com/watch?v=caoNxVPwO74>



□ Ergonomics simulation

‘The theoretical and fundamental understanding of human behavior and performance in purposeful interacting socio-technical systems, and the application of that understanding in order to design of interactions in the context of real settings’

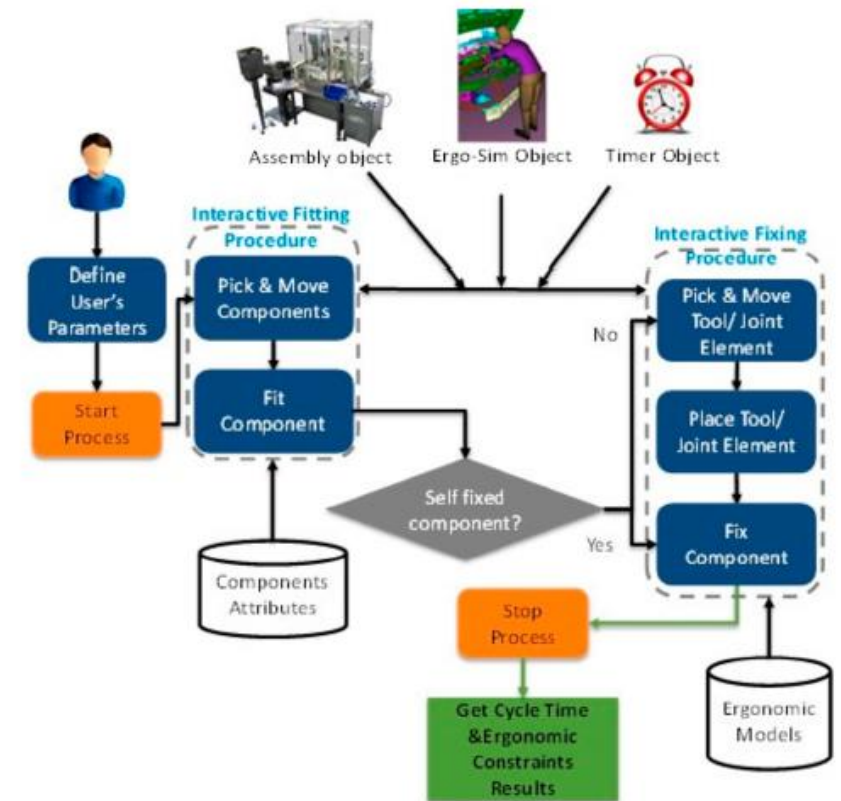
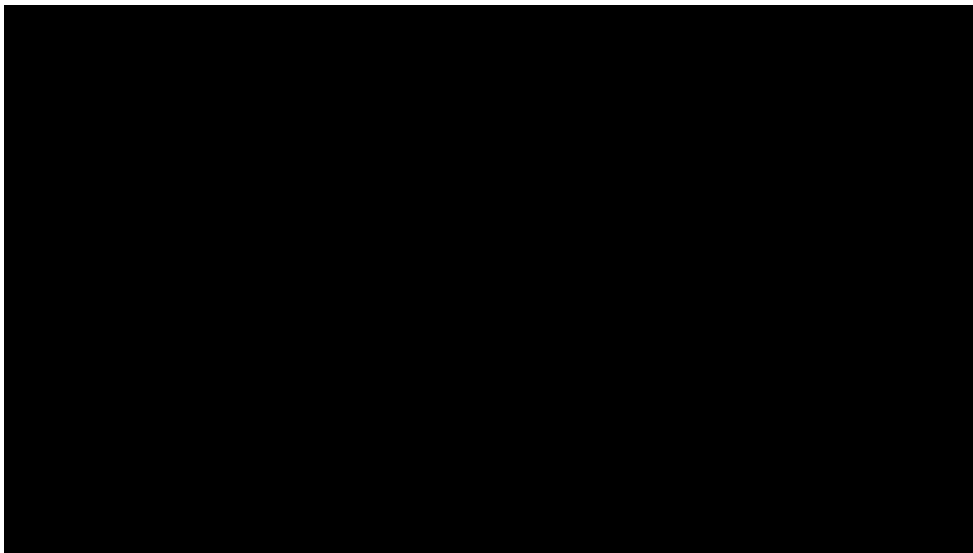

Source: The concept of the user workflow in the virtual environment (Chryssolouris et al. 2004).



Product and production lifecycle simulation

❑ Manufacturing Execution Systems

“Manufacturing Execution System (MES) is a system that supports manufacturers to attain constant product quality, comply with regulatory requirements, reduce time to market, and lower production costs”



Source: https://www.youtube.com/watch?v=YctPWZ4kr_s





Product and production lifecycle simulation

❑ Supervisory control and data acquisition

“Supervisory Control and Data Acquisition (SCADA) is the technology that enables data collection from one or more distant facilities while sending limited control instructions to those facilities”





Product and production lifecycle simulation

□ Supply chain simulation

“Supply chain is a value-adding chain of processes from the initial raw materials to the ultimate consumption of the finished product, spanning across multiple supplier-customer links”



Digitalization in simulation towards the 4th industrial revolution

□ Hybrid simulation

“A key approach to simulate complex systems that incubate both discrete event and continuous behavior is the utilization of hybrid simulation.”

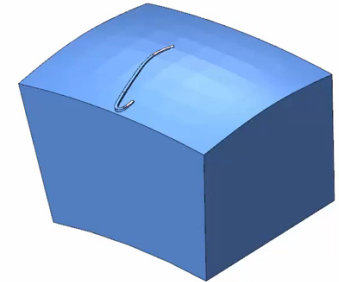
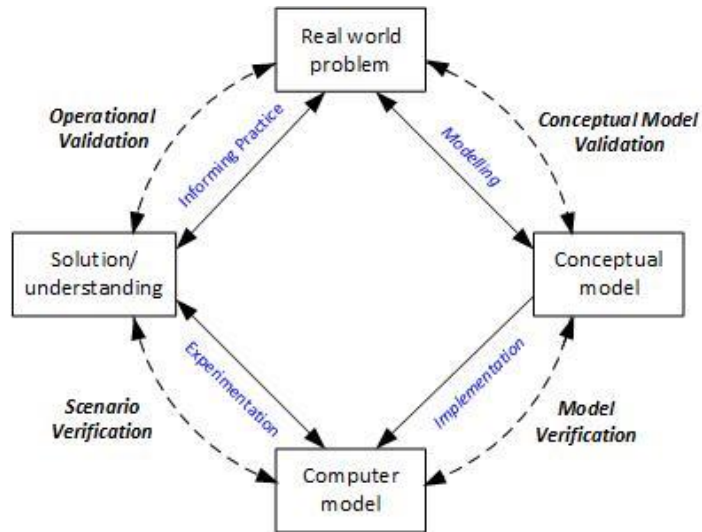

Digitalization in simulation towards the 4th industrial revolution

□ Digital twin

“Digital Twin is an integrated multiphasic, multiscale, probabilistic simulation of an as-built vehicle or system that uses the best available physical models, sensor updates, fleet history, etc., to mirror the life of its corresponding flying twin.”

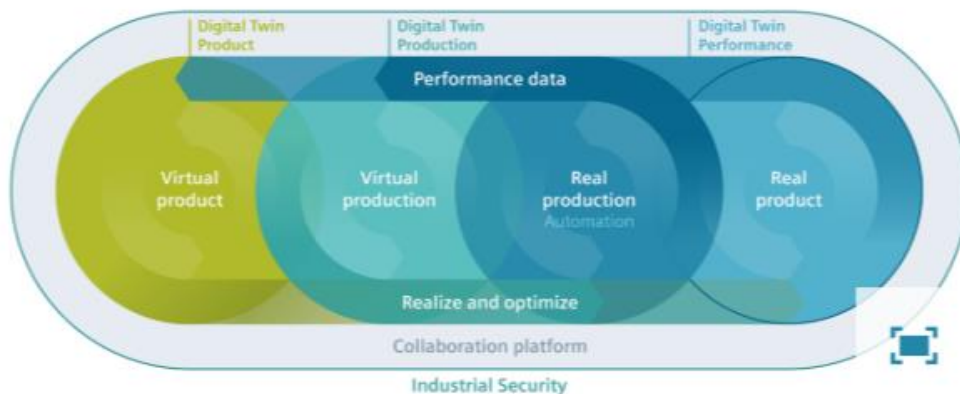

Source: SIEMENS

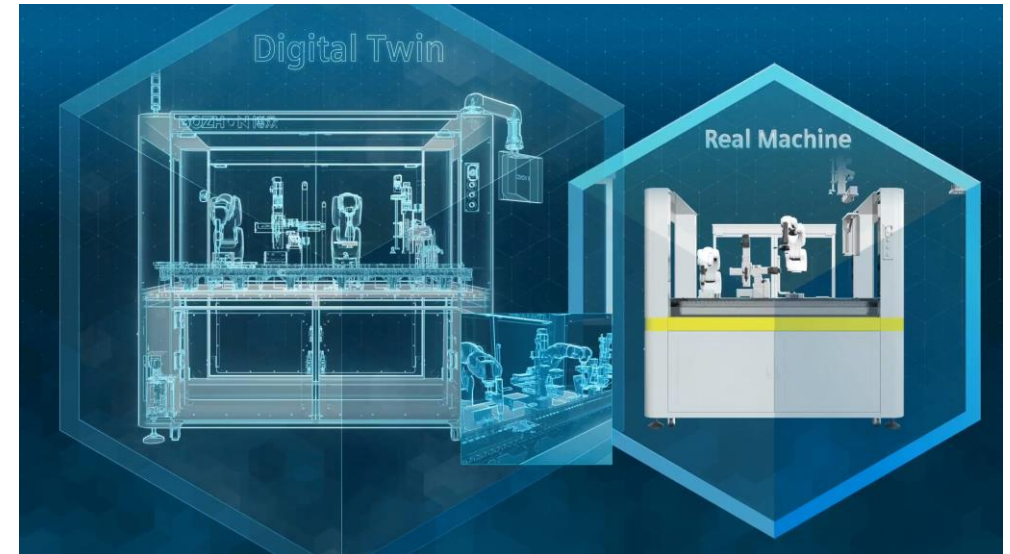

Source: SIEMENS

Co-funded by the
Erasmus+ Programme
of the European Union





Digitalization in simulation towards the 4th industrial revolution

□ Digital twin

Why digital twins will be the backbone of industry in the future

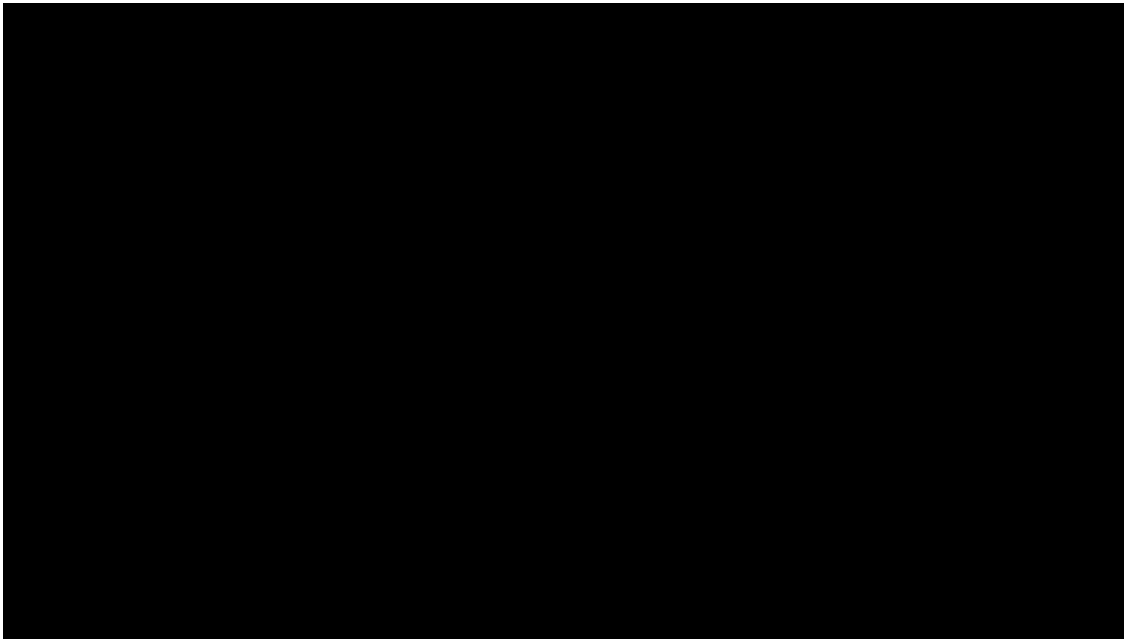

Simcenter 3D - 3D CAE for the digital Twin

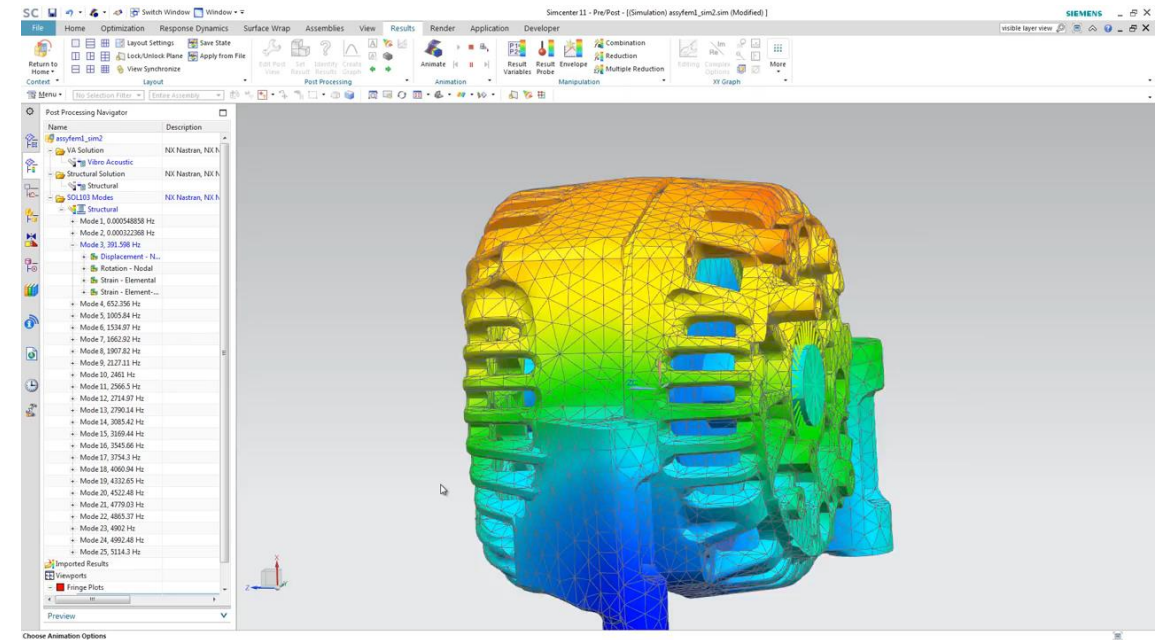

State of the market of simulation tools in the 4th industrial revolution

- Technology rushes forward to the new era of integration of Internet of Things in manufacturing
- The software solutions that aim to support the design and operation of such systems.
- The new era is characterized by an increased amount of data to be managed in real-time and feed simulation models
- Quickly investigate different scenarios and provide decision support Optimization of the system operation.



Major identified gaps for each product and production lifecycle sector.

Production Engineering in Digital Factory

- Integrating CAD designs and CAE information
- Synchronize the engineering processes that require the participation of the entire value chain and their access to all of the product information needed.
- Enable all of product-related teams to work together effectively without regard to physical location.
- Accelerate product delivery by enabling design teams to seamlessly collaborate with manufacturing teams.
- Establish product configurations re-useable across an entire product lifecycle and multiple products

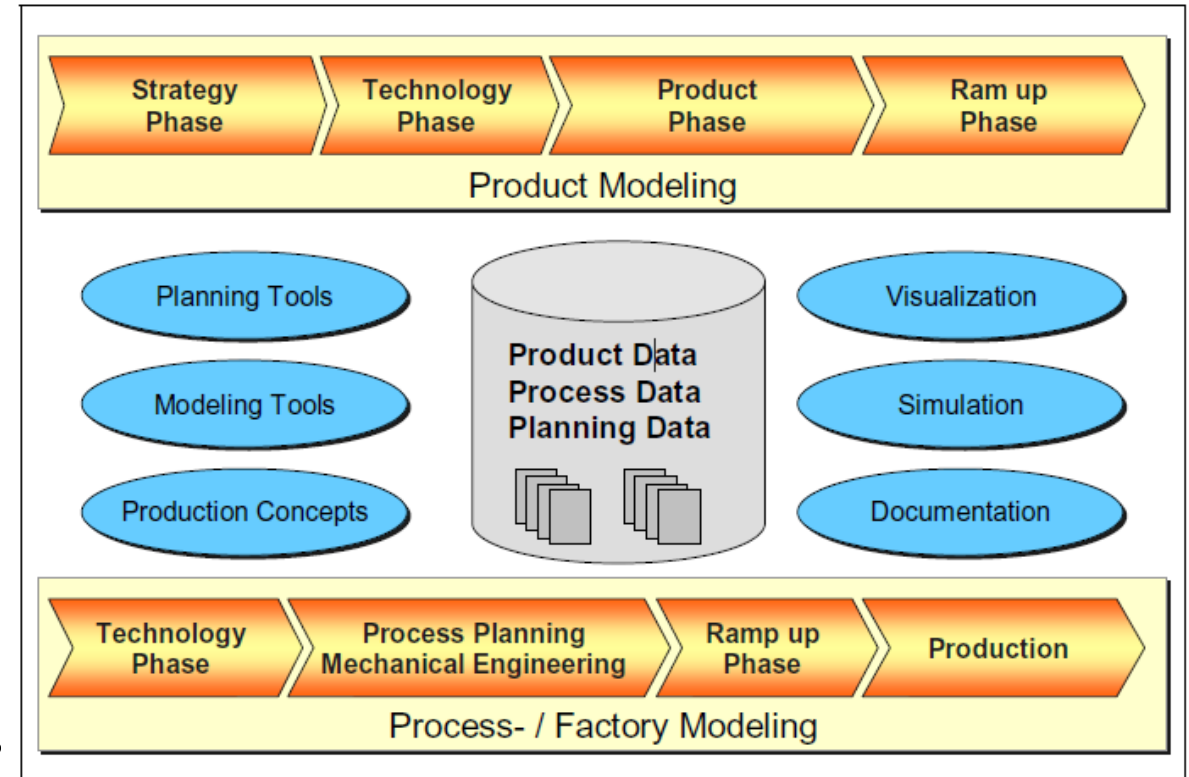

Digital Factory Concept

Factory design and Optimization in Digital Factory

- Shorten new product introduction, time-to-market, and time-to-volume
- Improve production layout and minimize investments
- Machines and equipment are in the right place
- Sufficient material handling equipment available
- Optimized buffer dimensions
- Product handling is kept to a minimum

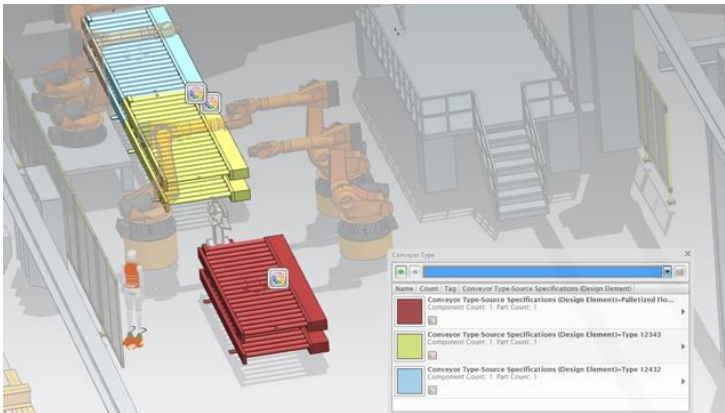

Visually Report and Document Factory and Line Designs

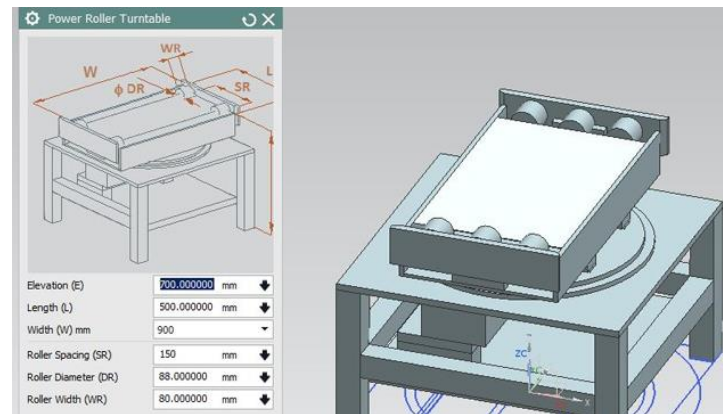

Conceptualize Production Layouts Using 3D

Co-funded by the
Erasmus+ Programme
of the European Union



Factory & Line Design

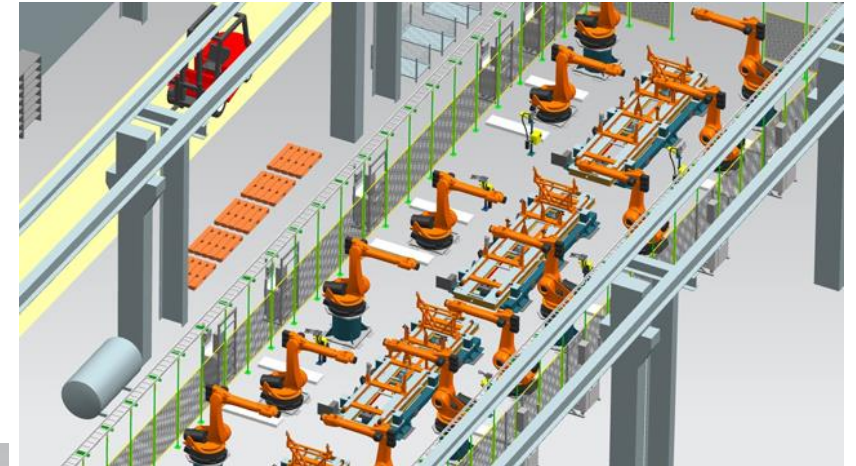

Integrate Layouts with Production Processes

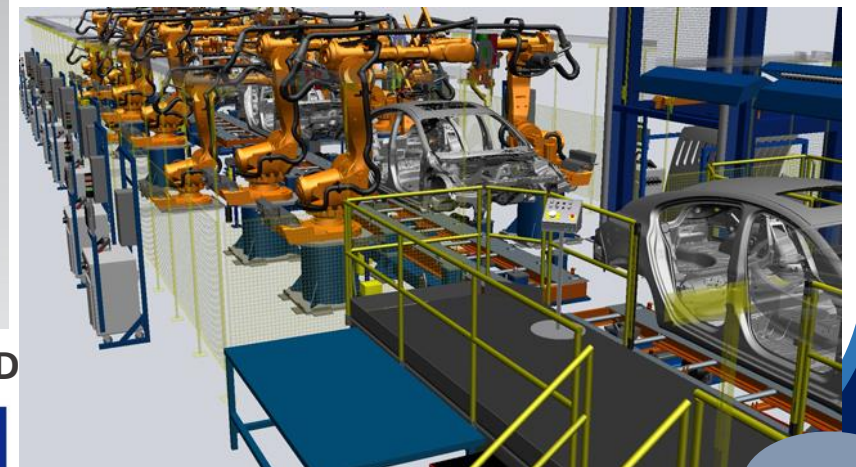

Simulation of Robotic Workcells

Digital manufacturing and simulation of robotic workcells focuses on the design, simulation, optimization, analysis and offline programming of robotic workcells and automated manufacturing processes in the context of product and production resource information.

- Shorten new product introduction, time-to-market, and time-to-volume
- Improve production layout and minimize investments
- Machines and equipment are in the right place
- Sufficient material handling equipment available
- Optimized buffer dimensions
- Product handling is kept to a minimum

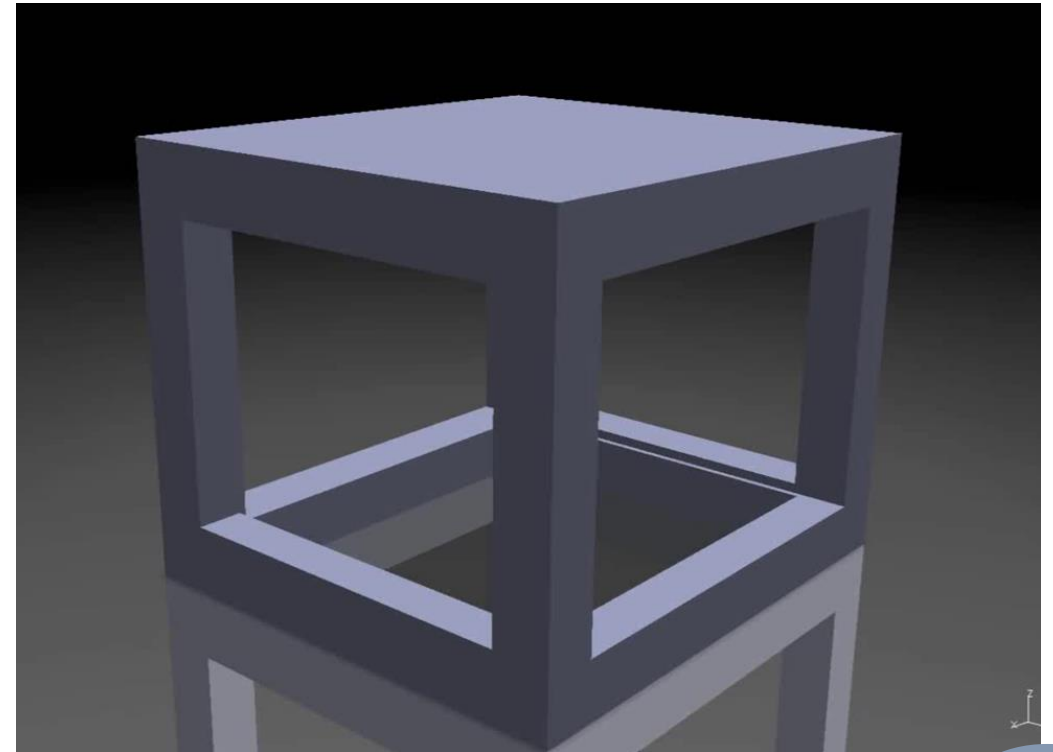

Simulation of Robotic Workcells



https://www.youtube.com/watch?v=JWPM_9bOMgU



<https://www.youtube.com/watch?v=orUsJV31H3o>

Human Resource Simulation

An accurate modelling, simulation and analysis of manual assembly designs, manual workplaces and human operations with detailed 3D virtual human models can optimize execution times and prevent work-related health problems. Human resource simulation focuses on:

- Detailed design of manual operations
- Checking the feasibility of tasks
- Ergonomic analysis
- Time analysis
- Generating work instructions





Plant Simulation software enables digitalization for the glass industry

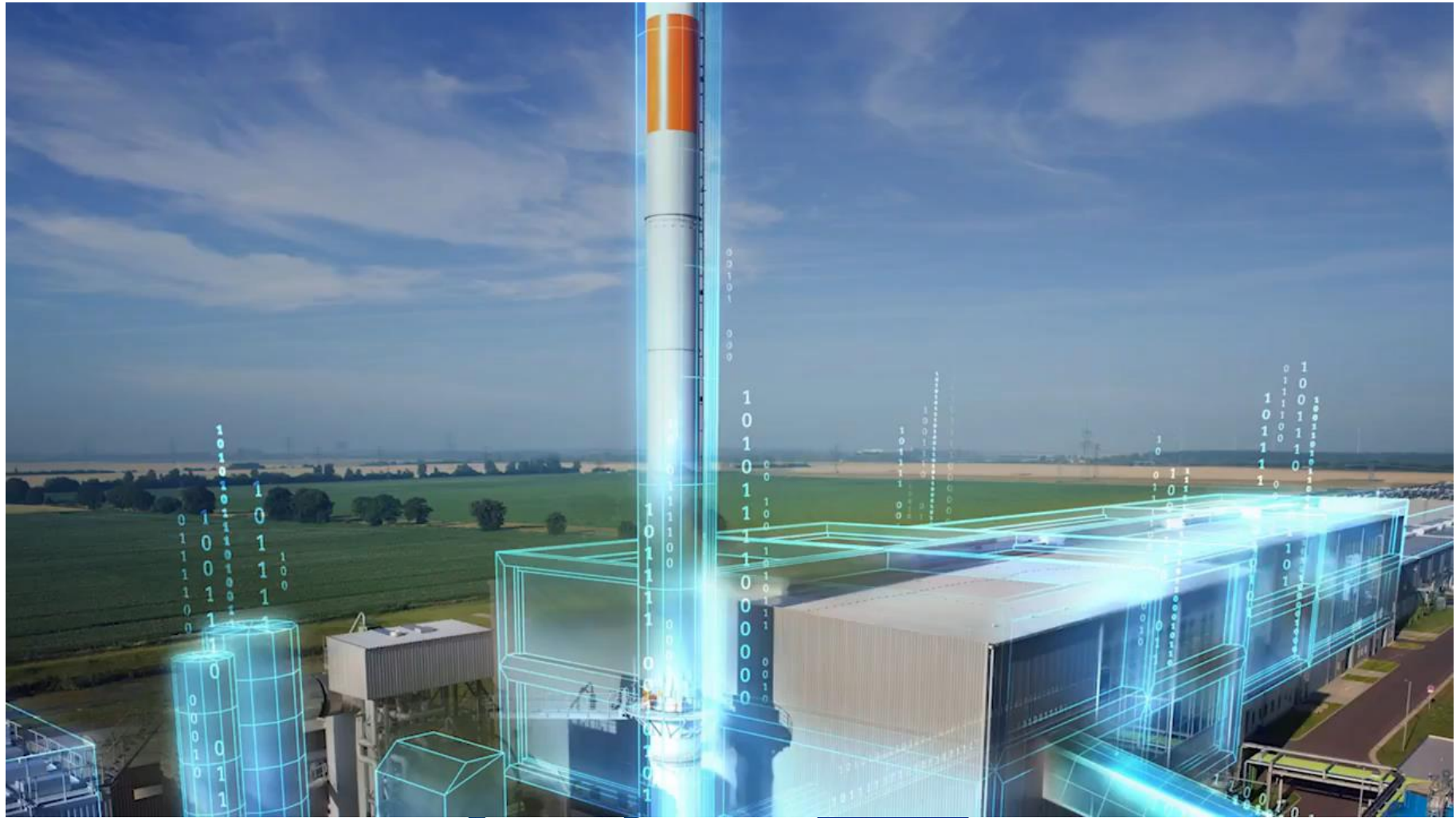



Siemens Tecnomatix Digital Industries Software

- Analyze Production Systems with 2D and 3D Statistical Simulation
- Eliminate Bottlenecks and Streamline Throughput
- Optimize Energy Usage for Improved Performance
- Virtually Commission Production Systems Prior to Startup



Source: <https://www.dtm-thailand.com/content/5302/tecnomatix>



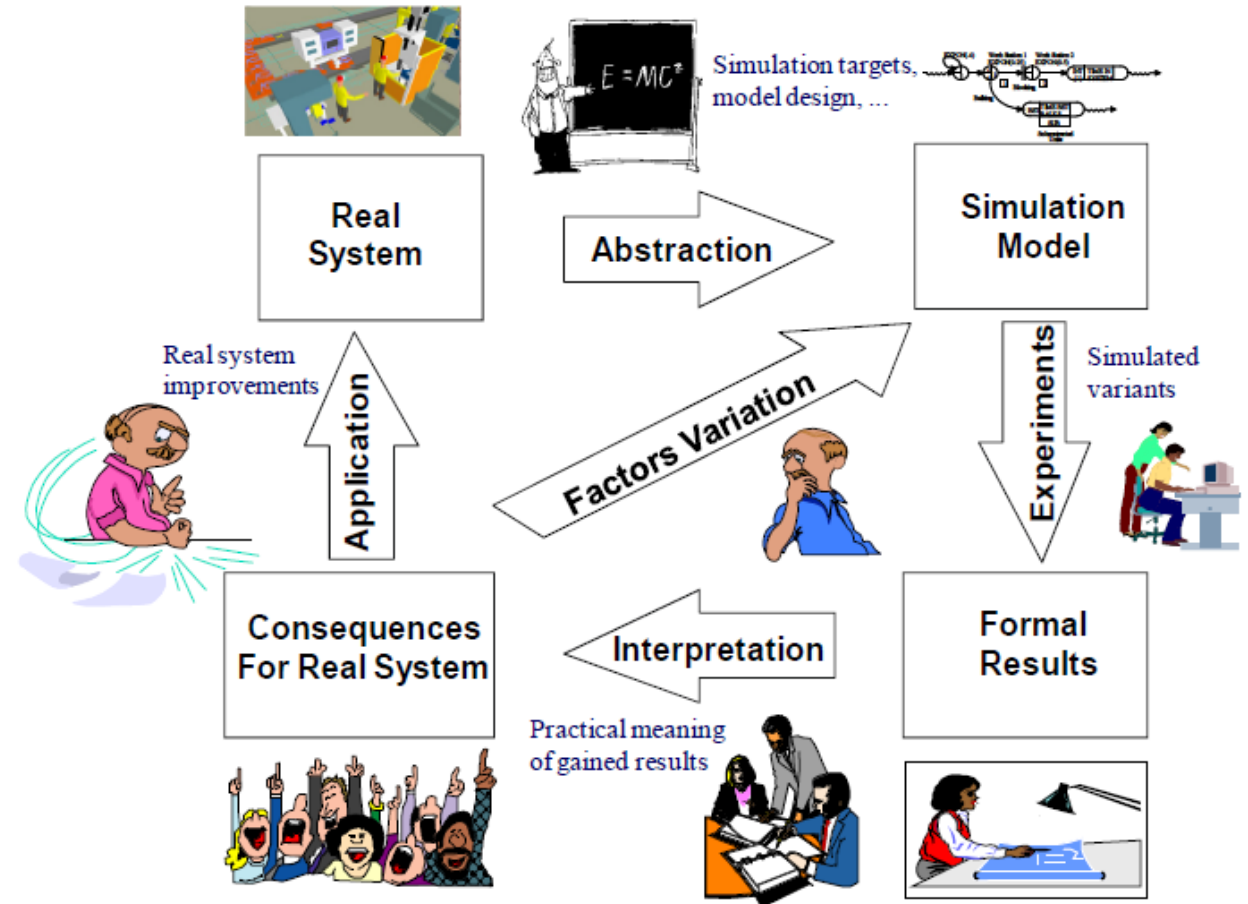

Principle of Computer Simulation (Milan Gregor and Stefan Medvecky, 2010)



Benefits, limitations and future challenges for new simulation approaches

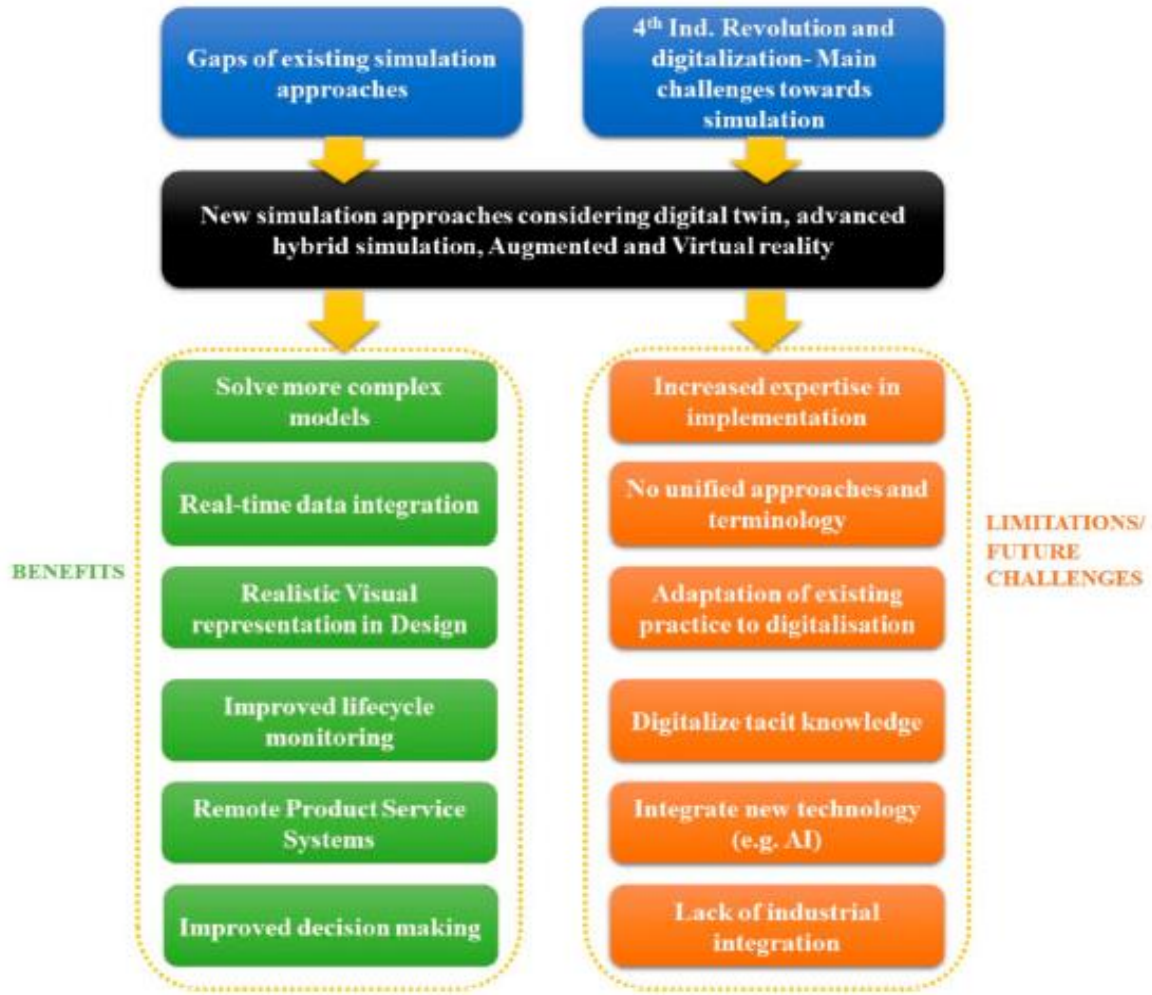

Activity (Lab Sheet)

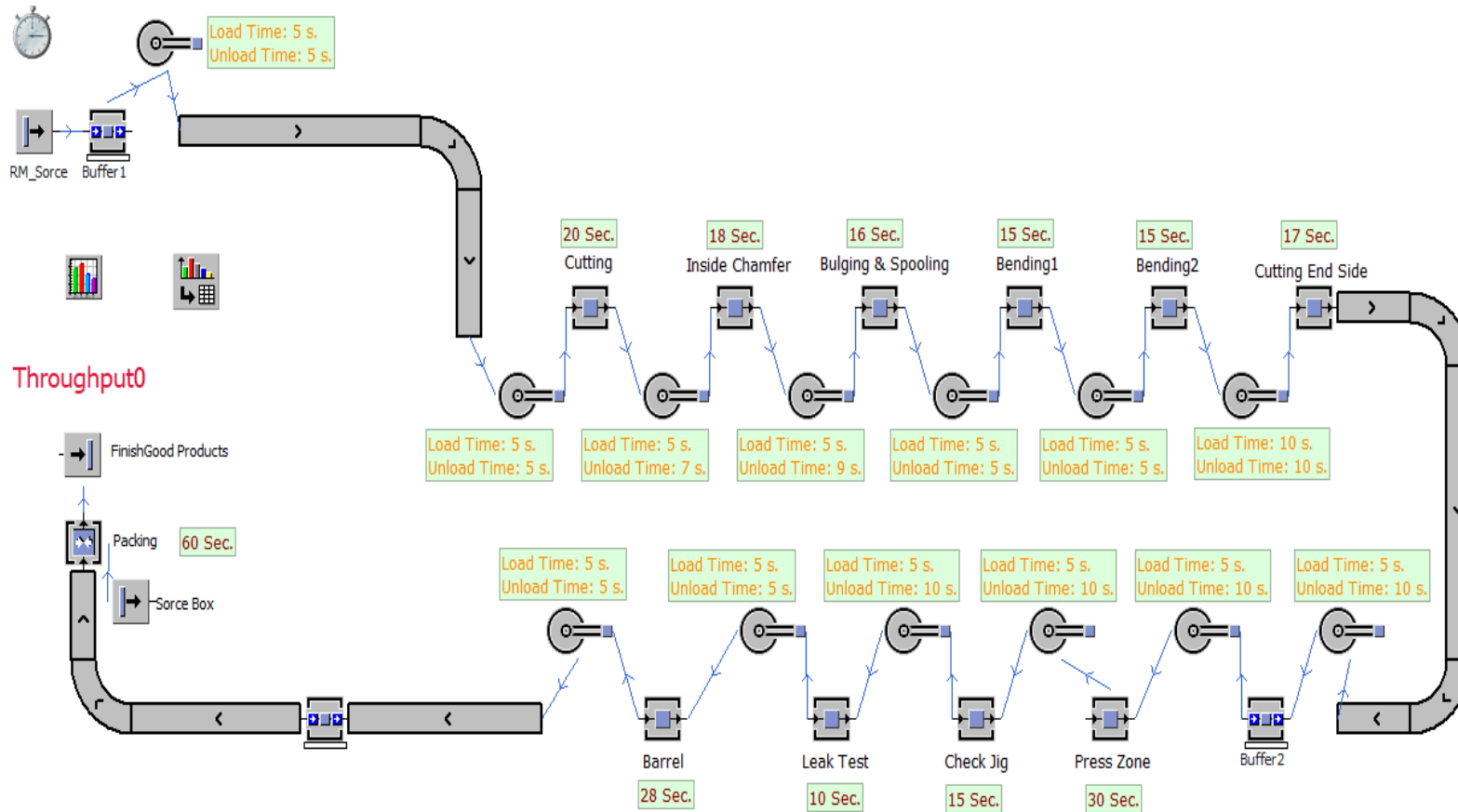

1. Determine the daily and weekly minimum production rate from simulation based on lab sheet condition.
2. Explain and compare the results from simulation and actual production rate of factory (1,200 pcs./day).
3. Explain the resource statistic in each station and improvement process for increase productivity or reduce waiting time and bottleneck problem.

Thank you

